

# Data Sheet



Article number: 20957442

Description: E+G Levelling foot  
GN 343.3-32-M8-A

## Measures

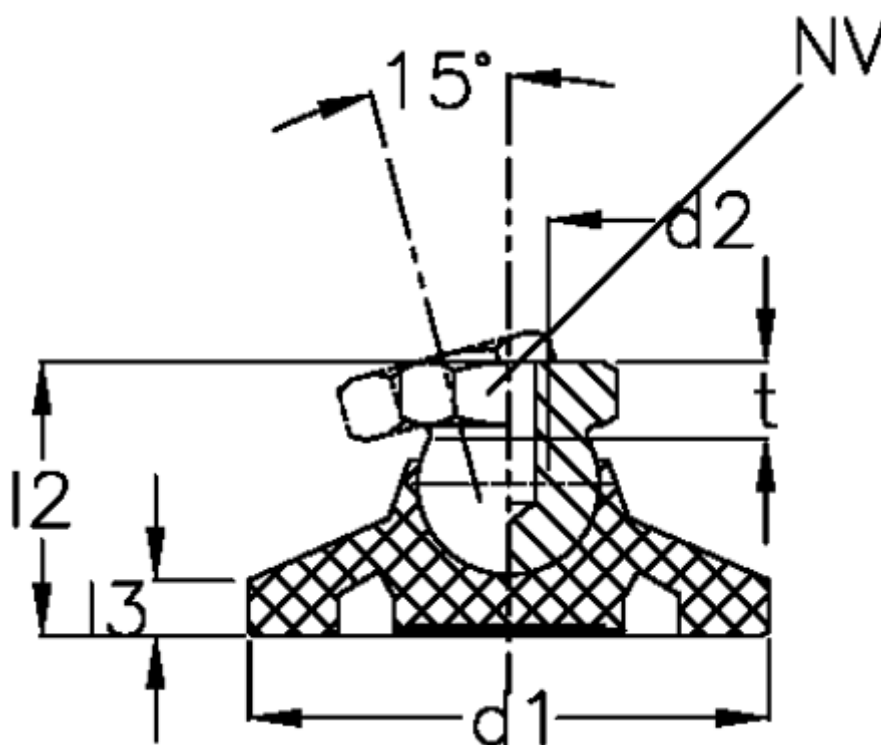

$d_1$	= 32
$d_2$	= M 8
$l_2$	= 22.5
$l_3$	= 5.0
$NV$	= 12.0
Static load (N)	= 7000
$t$ min	= 9.0